

whatsapp: +39 366 222 91 84

IMPORTANTE

Prima di procedere con l'installazione del prodotto:

- controllare la compatibilità tra dimensioni della cabina e piatto doccia;
- verificare la presenza di danni dovuti al trasporto;
- verificare la perfetta planarità del piatto doccia/pavimento;
- controllare che i punti di fissaggio non coincidano con linee elettriche, gas o idriche;
- verificare che le superfici su cui dovrà essere installata la cabina siano pulite, portanti e planari.

In caso di difformità non procedere con l'installazione e contattare tempestivamente l'azienda. Non si accettano reclami per danni su prodotti già installati.

Non costituiscono motivo di reclamo le perdite d'acqua causate da getti d'acqua puntati direttamente su vetri e guarnizioni.

INSTALLAZIONE

Viti e tasselli forniti a corredo del prodotto sono adatti per muratura in laterizio. Per l'installazione su altre pareti utilizzare fissaggi appositi. L'installazione deve essere eseguita solo da personale esperto; un montaggio non conforme alla presente istruzione invalida la garanzia.

La siliconatura della cabina doccia deve essere effettuata tassativamente all'esterno come indicato in seguito.

La regolazione finale dei cuscinetti delle porte scorrevoli e il serraggio delle viti delle cerniere deve sempre essere verificata. La rottura del vetro della porta è spesso causata da urti dovuti ad una carente regolazione o serraggio inadeguato dei cuscinetti.

RACCOMANDAZIONI PER L'USO E LA MANUTENZIONE

È assolutamente vietato dirigere il getto d'acqua a diretto contatto con i vetri e le guarnizioni.

Asciugare sempre la cabina doccia dopo l'uso per evitare la formazione di depositi di calcare.

Per la pulizia utilizzare detergenti non aggressivi con panno morbido o spugna. Sugeriamo di impiegare una soluzione di aceto tiepido e bicarbonato.

Evitare prodotti in pasta, candeggina, alcool, acetone, solventi e prodotti particolarmente acidi.

Se in fase di utilizzo nel tempo il prodotto dovesse subire perdite di funzionalità (scorrimento difficoltoso, allentamento cerniere...) contattare immediatamente l'azienda per evitare danni irreparabili.

IMPORTANT

Before proceeding with the installation of the product:

- check compatibility between cabin dimensions and shower tray;
- check for transport damage;
- check the perfect flatness of the shower / floor plate;
- check that the fixing points do not coincide with electric, gas or water lines;
- check that the surfaces on which the cabin is to be installed are clean, load-bearing and planar.

In case of non-conformity, do not proceed with the installation and contact promptly the company. We do not accept claims for damages on products already installed.

Water losses caused by jets of water aimed directly on glasses and gaskets do not constitute grounds for complaint.

INSTALLATION

Screws and dowels supplied with the product are suitable for brick masonry. To install on other walls, use special fasteners. Installation must be performed only by expert personnel; an assembly that does not comply with this instruction will invalidate the warranty.

The siliconization of the shower enclosure must be carried out strictly outside as indicated below.

The final adjustment of the sliding door bearings and the tightening of the hinge screws must always be checked. Breakage of the glass of the door is often caused by impacts due to inadequate adjustment or tightening of the bearings.

RECOMMENDATIONS FOR USE AND MAINTENANCE

It is absolutely forbidden to direct the water jet in direct contact with the glasses and gaskets.

Always dry the shower enclosure after use to avoid limescale deposits.

For cleaning, use non-aggressive detergents with a soft cloth or sponge. We suggest using a solution of warm vinegar and bicarbonate.

Avoid products in paste, bleach, alcohol, acetone, solvents and particularly acid products.

If during use the product should suffer loss of functionality (difficult sliding, loosening hinges ...) contact the company immediately to avoid irreparable damage.

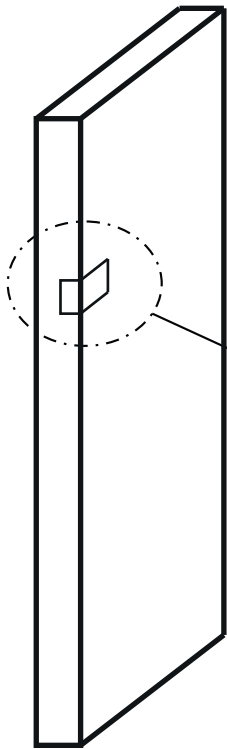

MIN - MAX

0101011332
XXXXXXXXXXXX A 77-79 ARG SAT PIUM

FIX (Fisso) DOOR (Porta)
XXXXXXXXXXXX

Ns: xxxxx
Vs: xxxxxxx
OP:xxxx

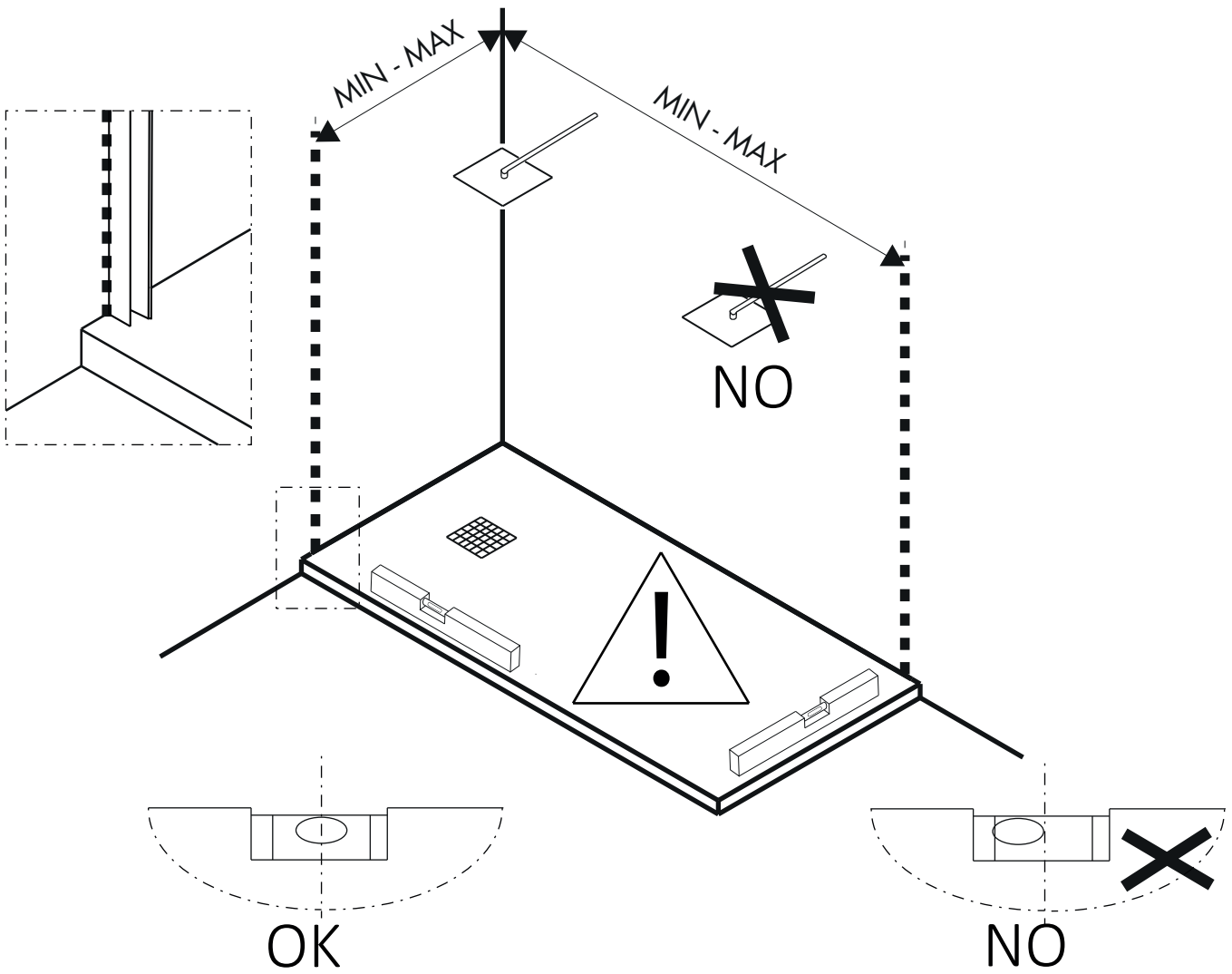

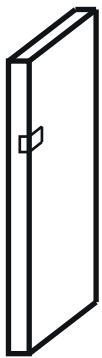

V1_N°3pz 3,9x32

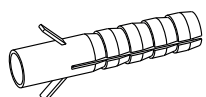

V2_N°3pz

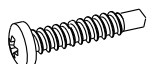

V3_N°3pz



T1_N°6pz

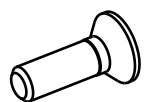

V6_N°3pz 2,9x13

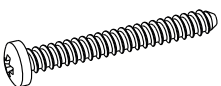

V5_N°4pz 3,5x50

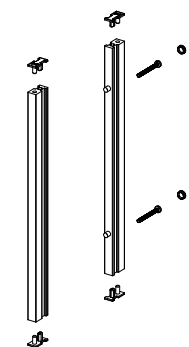

M1_N°1pz

4

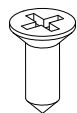

V7_N°4pz 3,5x9,5

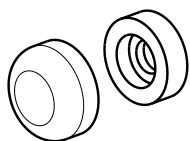

T2_N2

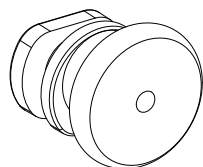

R1_N2

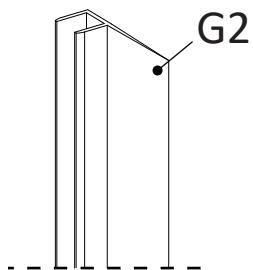

G2

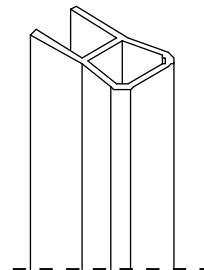

G1

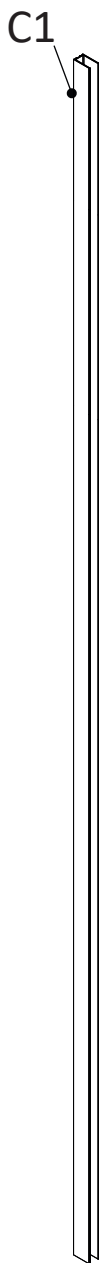

C1

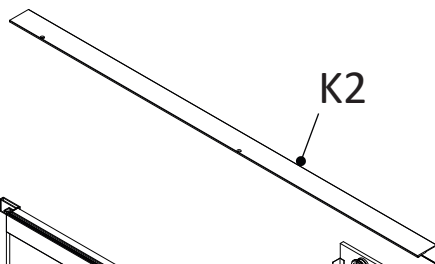

K2

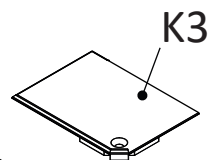

K3

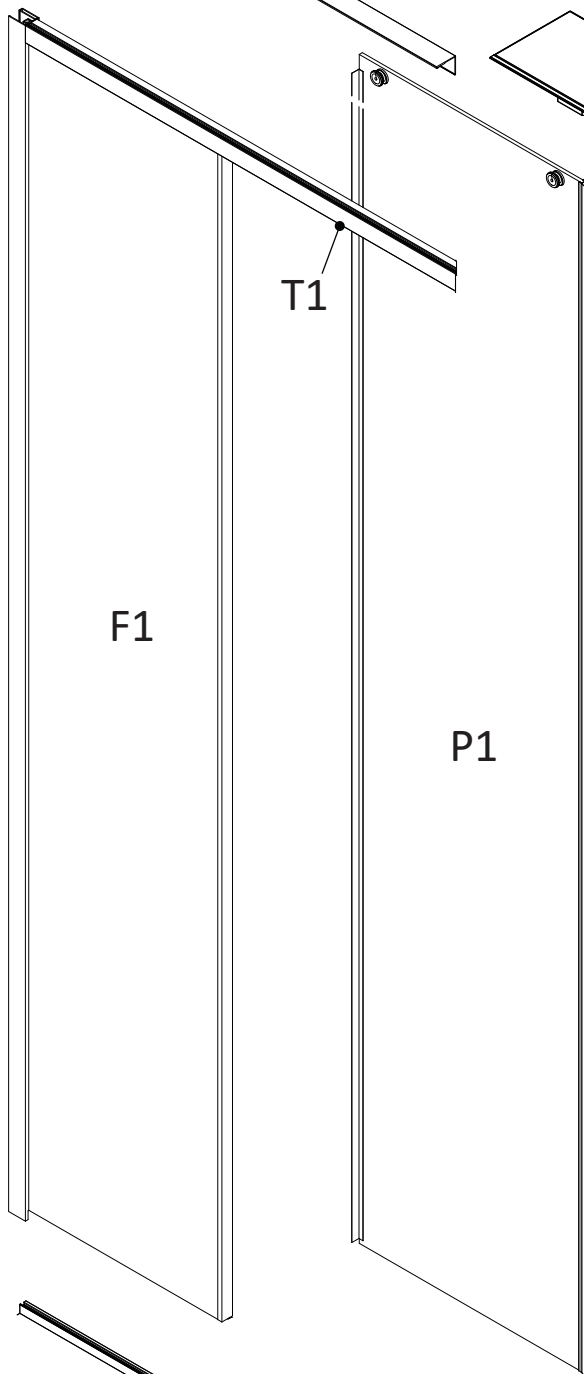

F1

T1

P1

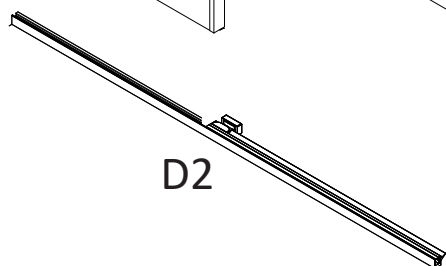

D2



D1

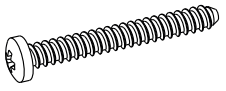
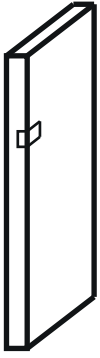

V1_N°3pz 3,9x32

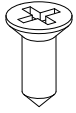

V7_N°4pz 3,5x9,5

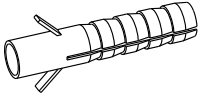

V2_N°3pz

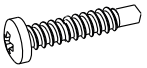

V3_N°3pz



T1_N°6pz

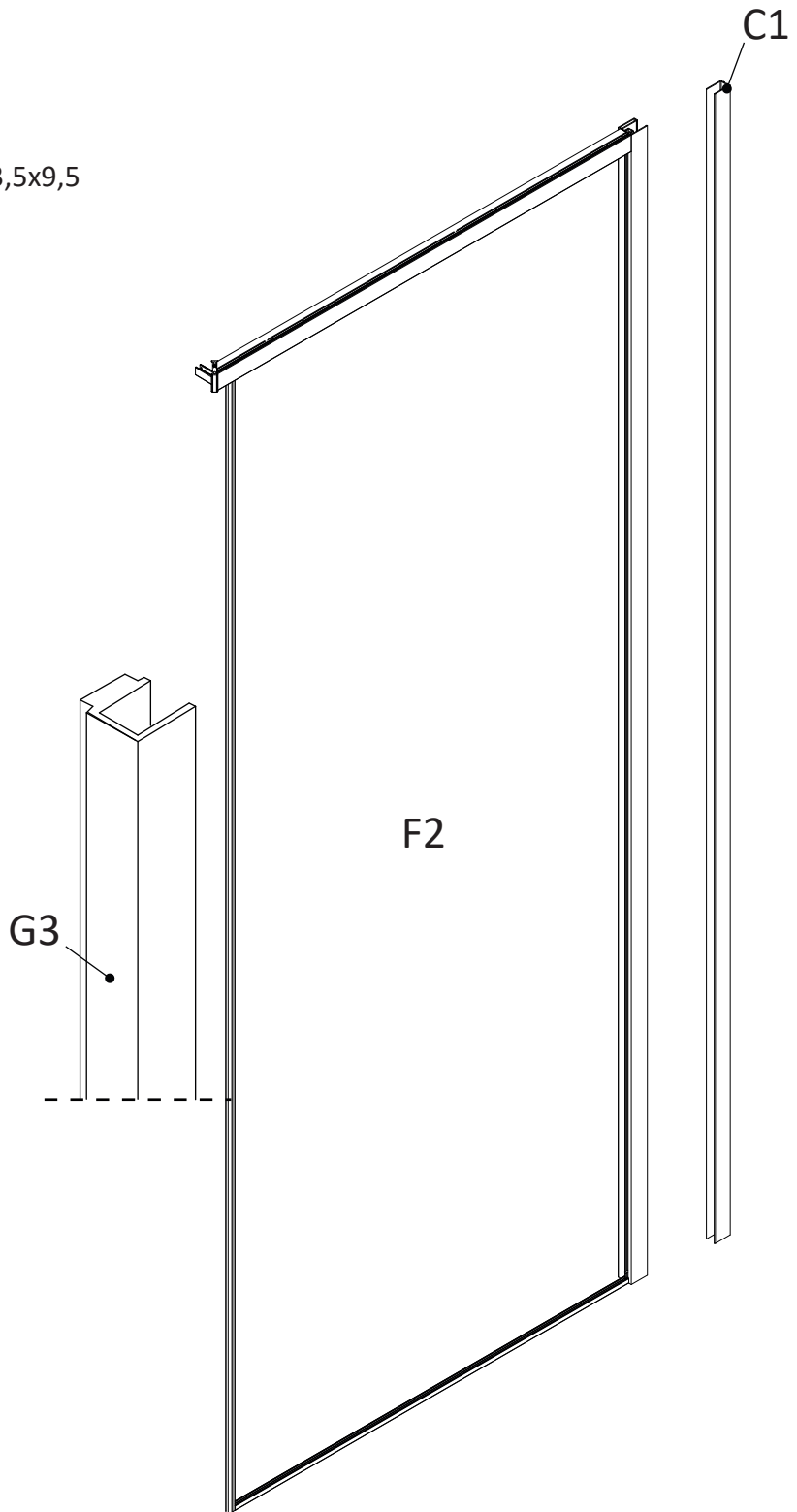

MIN - MAX

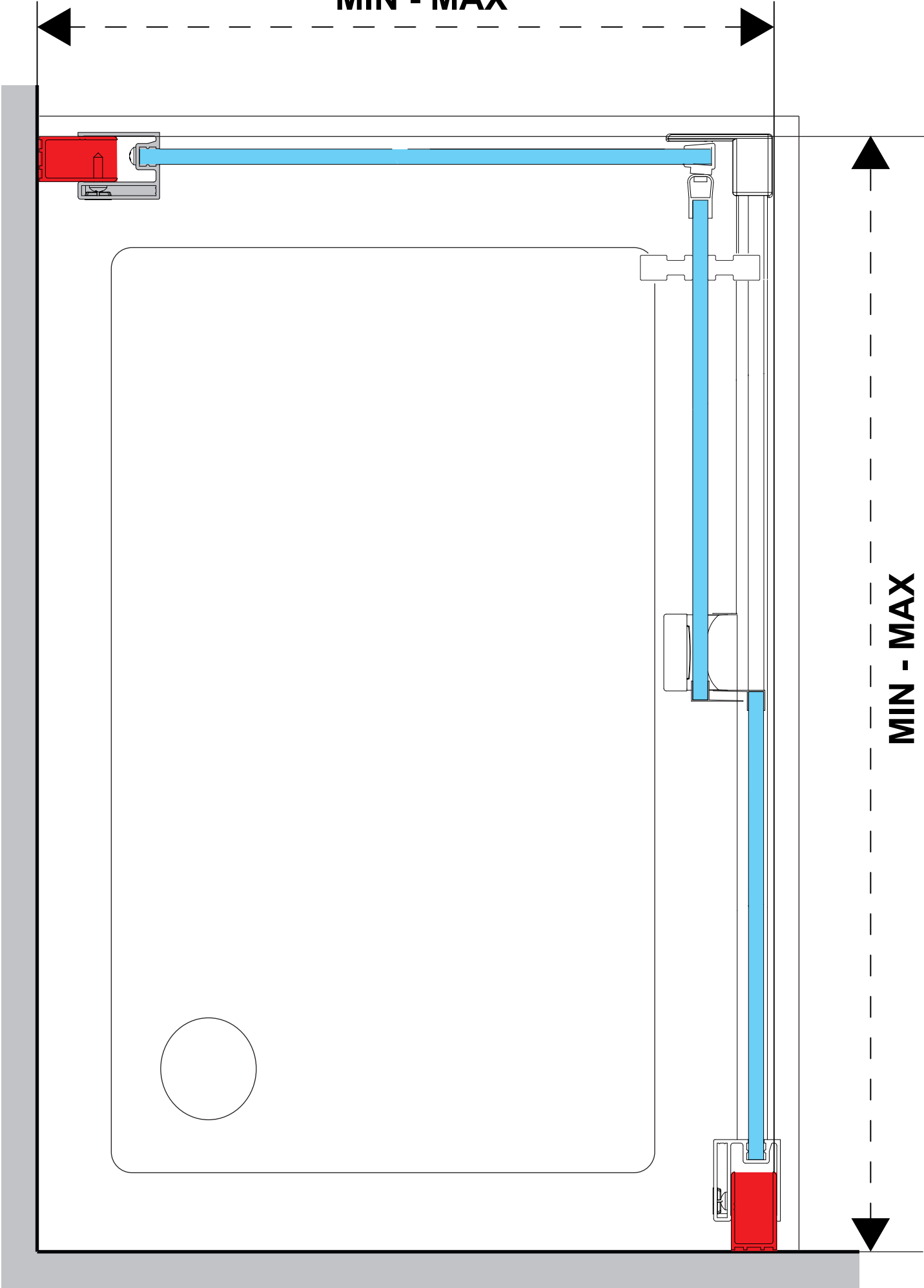

MIN - MAX

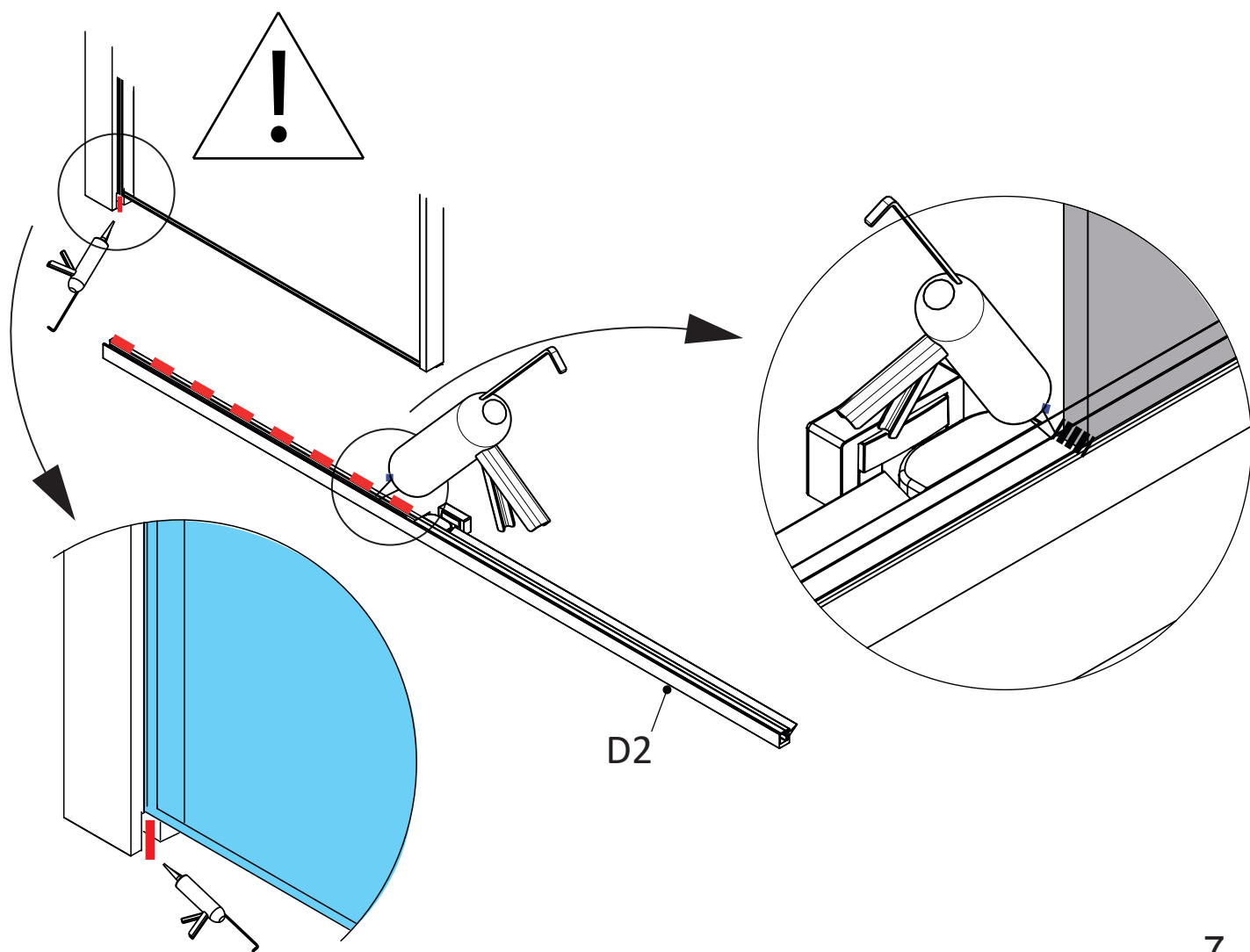
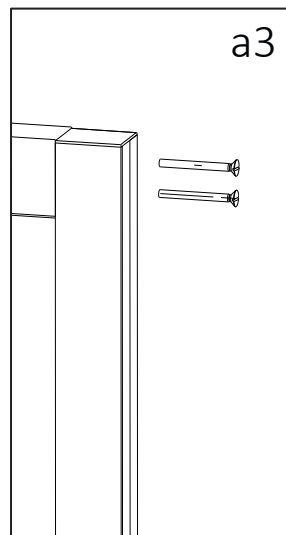
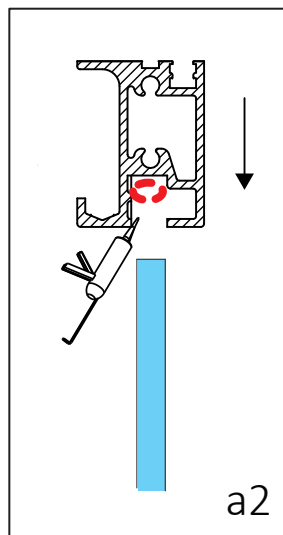
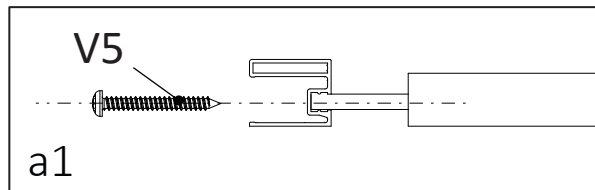
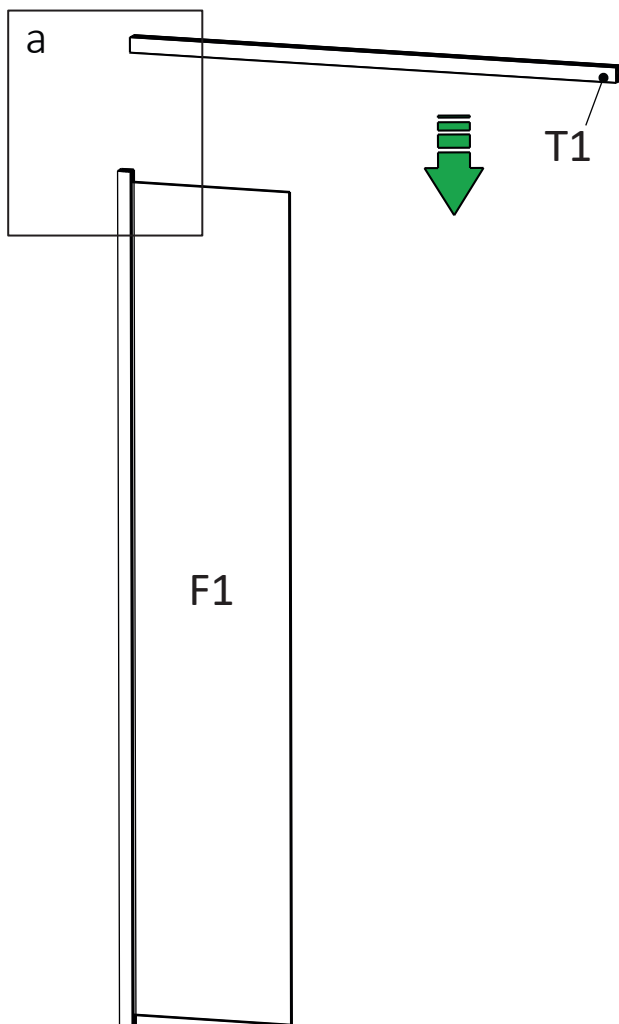

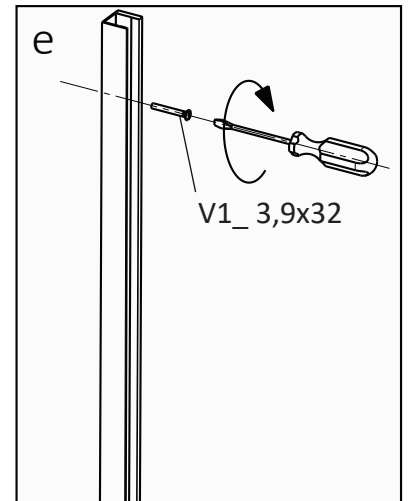
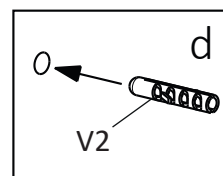
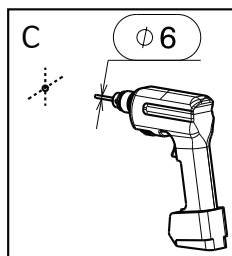
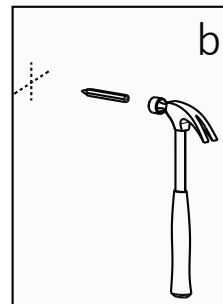
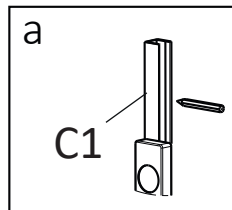
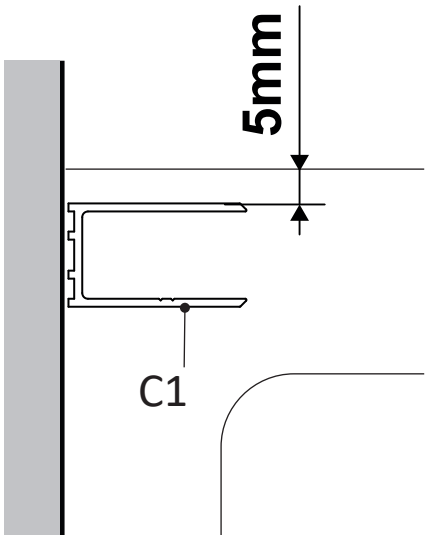
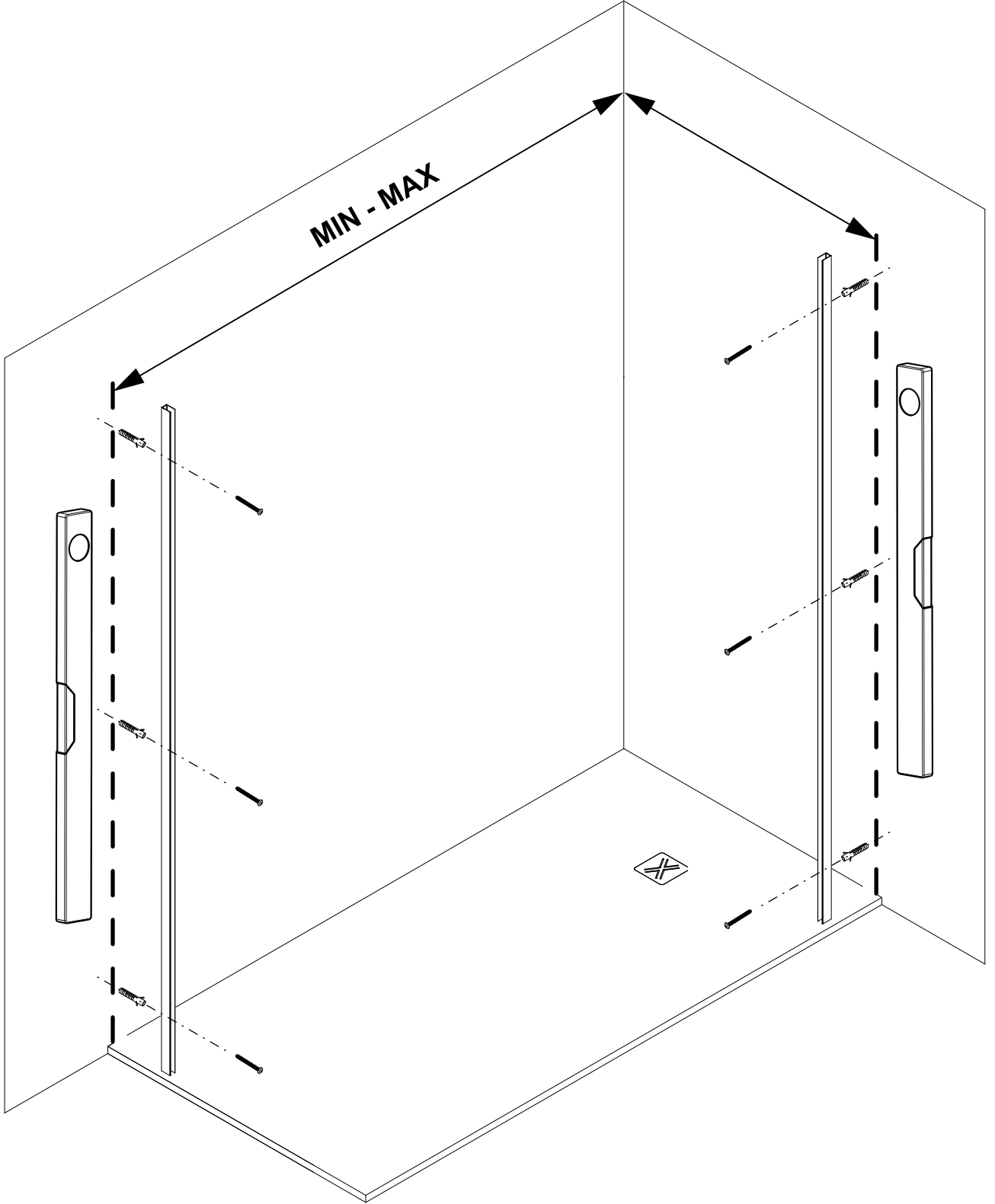

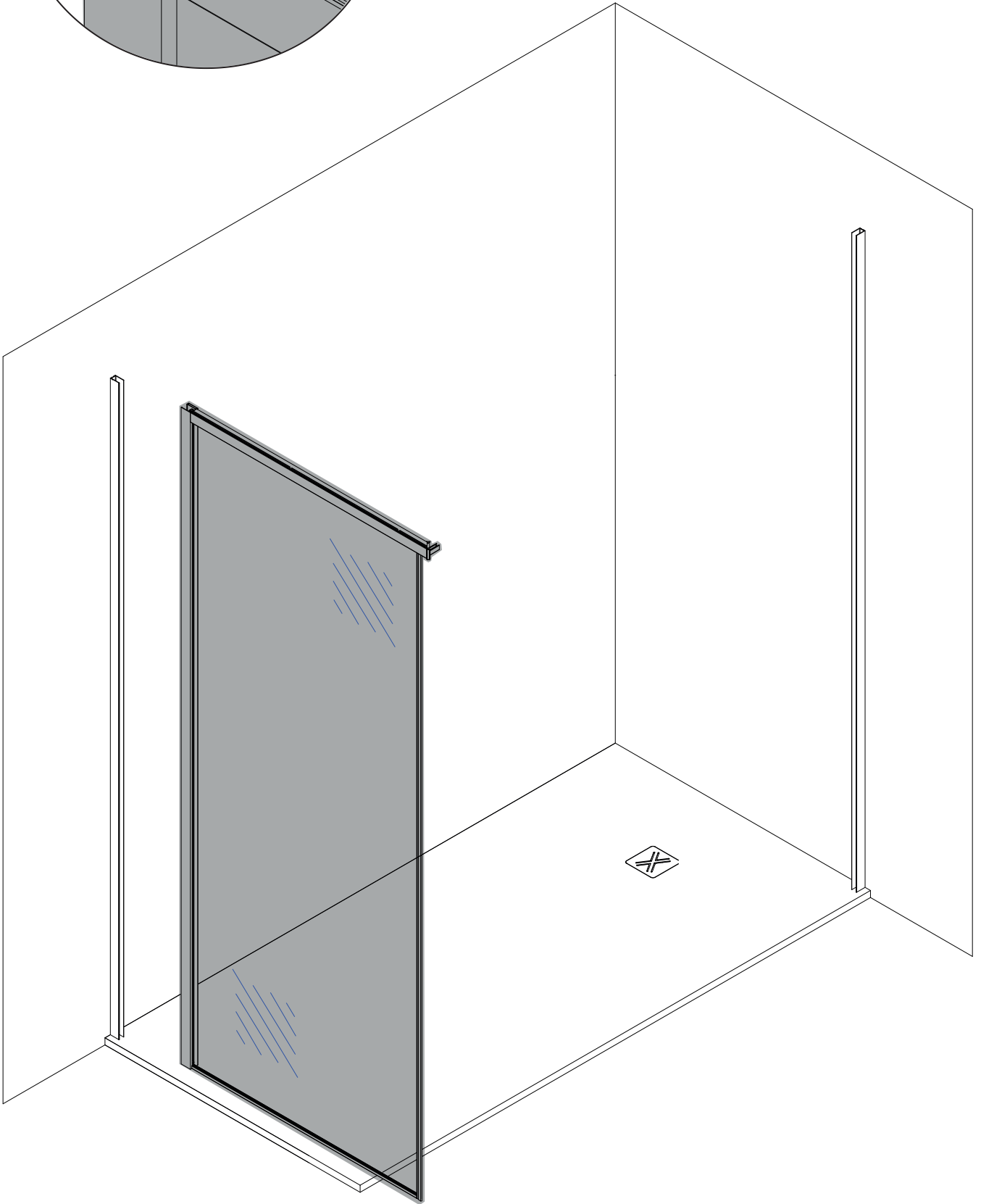
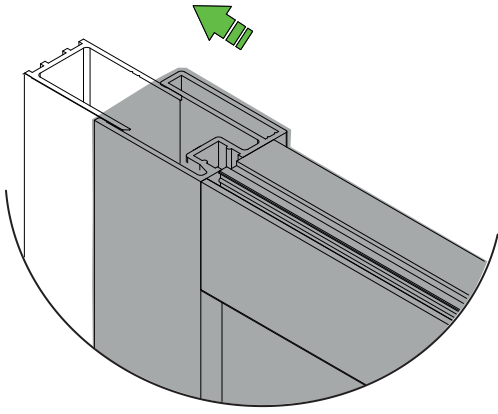

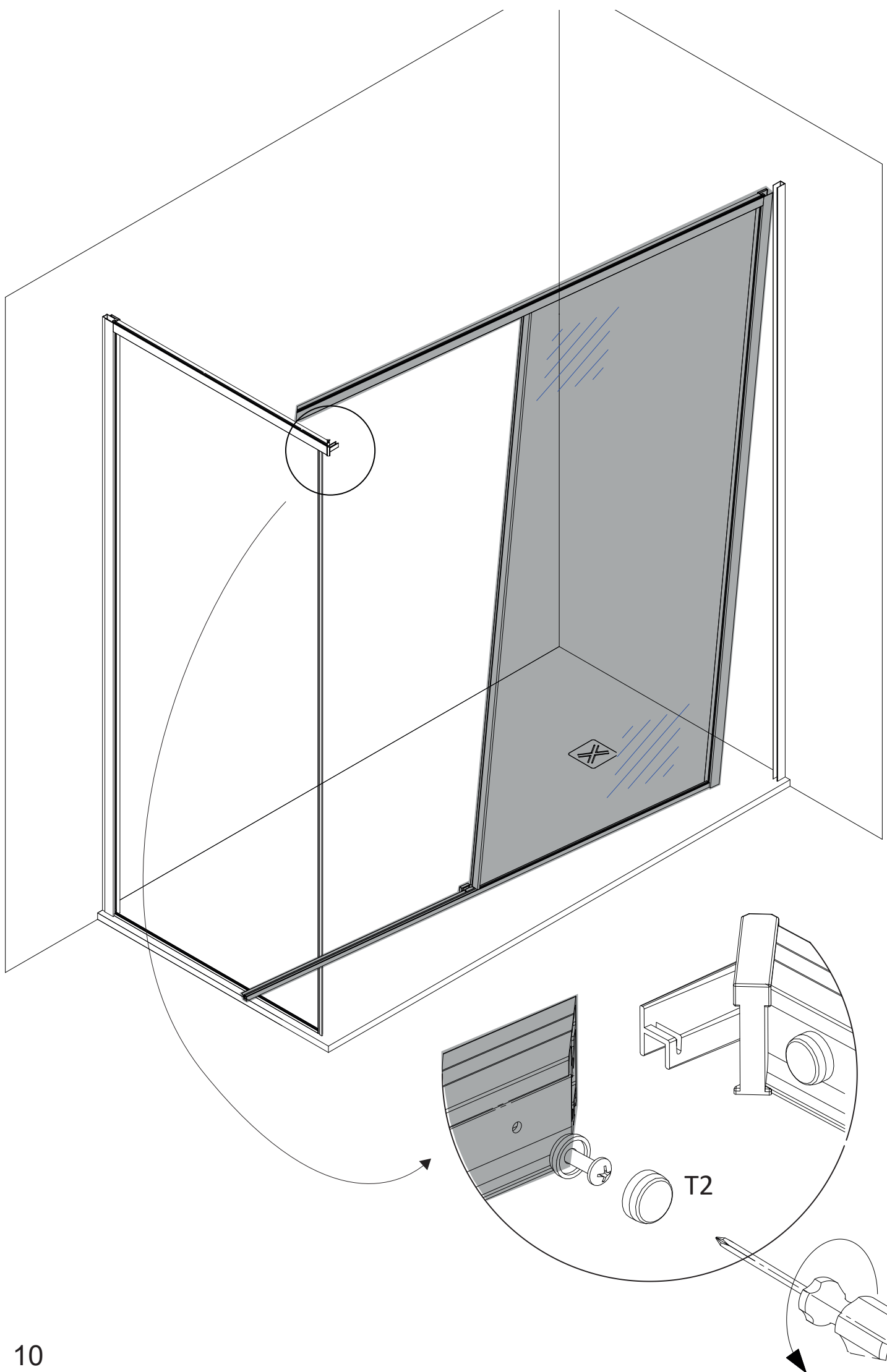

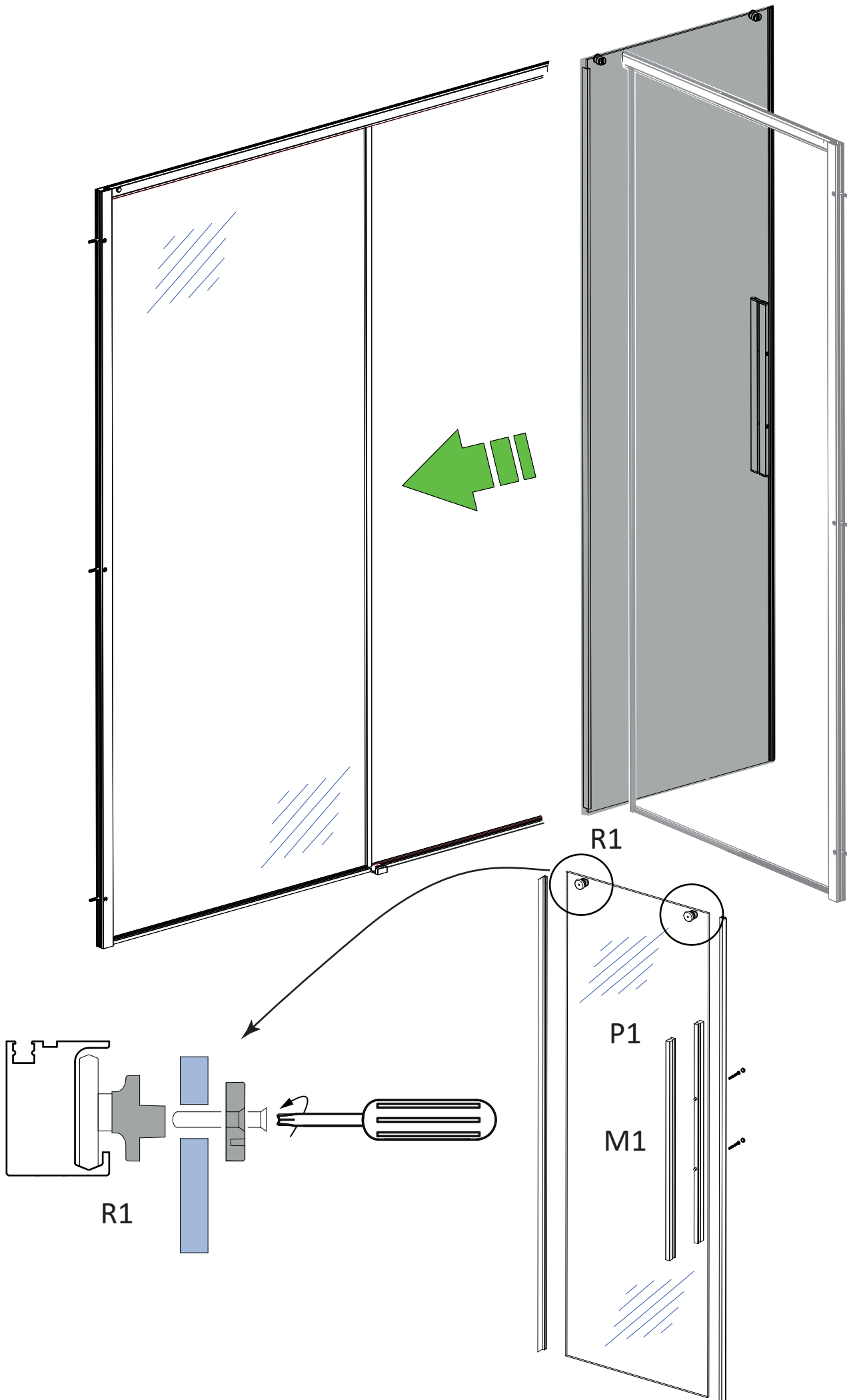

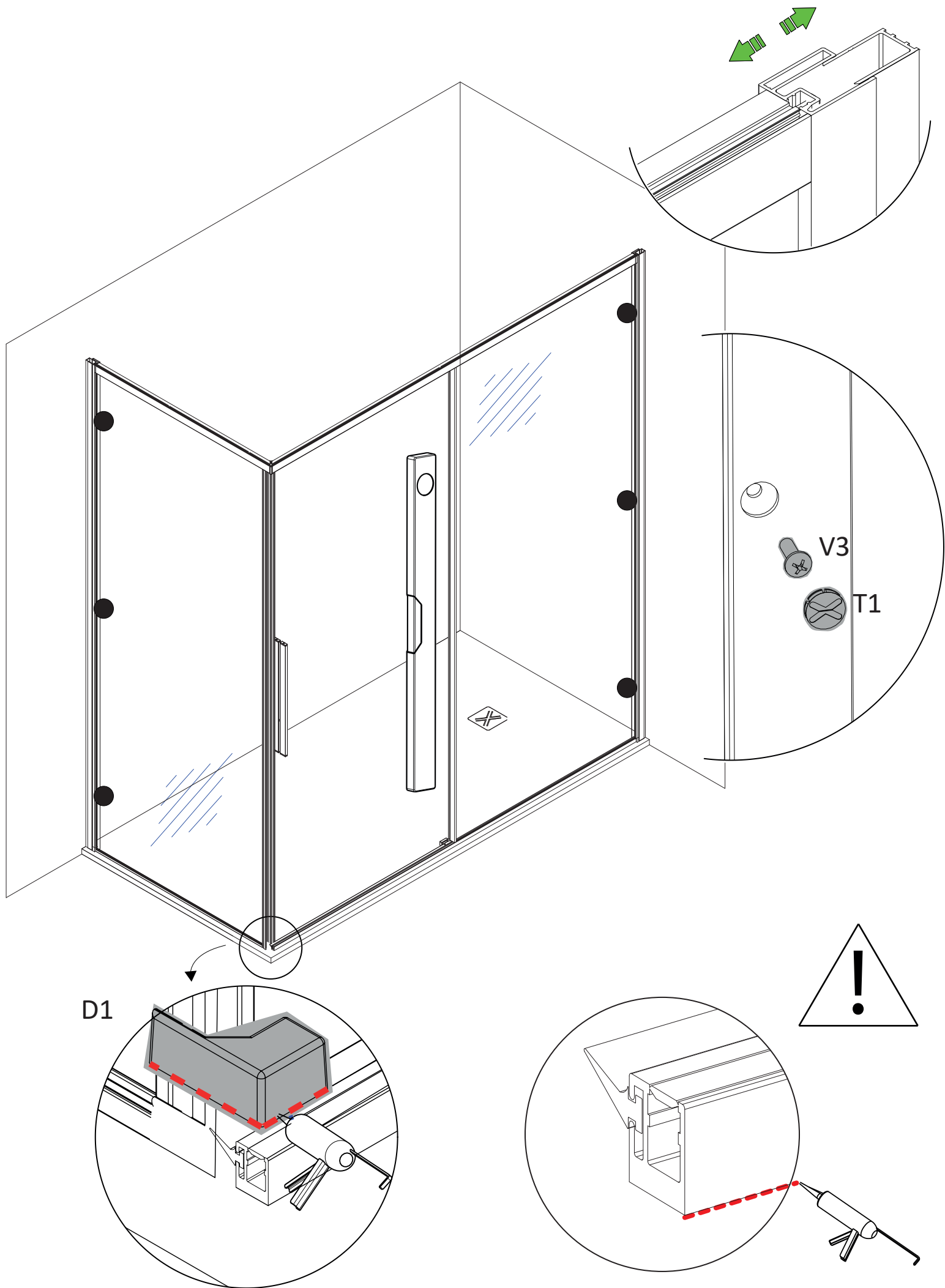

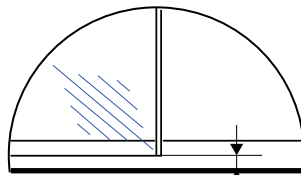
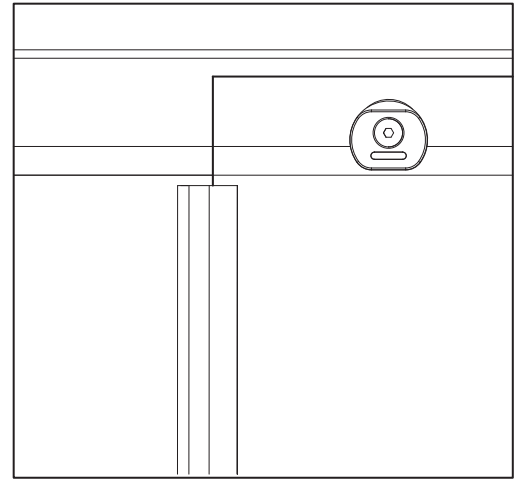
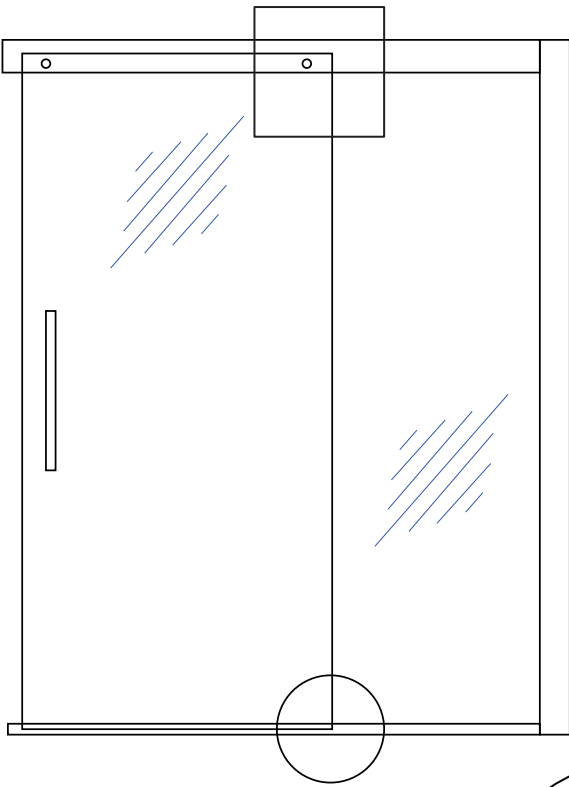

5mm

